

Thermocouple for flue gas temperature measurements With protection tube model TW81 Model TC81

WIKA data sheet TE 65.81



for further approvals
see page 2

Applications

- Blast furnaces, hot blast stoves
- Annealing and heat treatment processes
- Waste and hazardous waste incineration
- Large heating systems, heat generation

Special features

- Application ranges up to +1,200 °C (+2,192 °F)
- Protection tube from heat-resistant steel
- Measuring insert replaceable
- Gas-tight process connection (option)

Description

These straight thermocouples consist of a form B connection head, a measuring insert in accordance with DIN 43735 and a model TW81 protection tube. In addition to DIN form A or C protection tubes, customer-specific versions are possible. Possible process connections are stop flange or threaded bushing - the latter can realise a gas-tight connection.

These thermometers are suitable for gaseous media in the low pressure range (up to approx. 1 bar). Different protection tube materials, with or without enamelling, ensure matching to the respective thermal load.

Measuring insert is replaceable. This enables inspection, measuring equipment monitoring or, when servicing is necessary, replacement while the plant is running. The choice of standard lengths assists with short delivery times and the possibility of stocking spare parts.



Thermocouple for flue gas temperature measurements, model TC81

Protection tube material, connection head and sensor can each be selected to suit the respective application.

Optionally, a transmitter can be built in. Among the advantages of a built-in transmitter is an increased reliability of the signal transmission.

Explosion protection (option)







The permissible power, P_{max} , as well as the permissible ambient temperature, for the respective category can be seen on the EC-type examination certificate and the certificate for hazardous areas or the operating instructions.

Attention:









Only with the correspondingly suitable protective components is operation in dust Ex hazardous areas permissible.

Built-in transmitters have their own EC-type examination certificate. The permissible ambient temperature ranges of the built-in transmitters can be taken from the corresponding transmitter approval.



Approvals (explosion protection, further approvals)

Logo	Description	Country
 	EU declaration of conformity <ul style="list-style-type: none"> ■ EMC directive ¹⁾ EN 61326 emission (group 1, class B) and immunity (industrial application) ■ RoHS directive ■ ATEX directive (option) Hazardous areas <ul style="list-style-type: none"> - Ex i Zone 0 gas [II 1G Ex ia IIC T1 ... T6 Ga] Zone 1 mounting to zone 0 gas [II 1/2G Ex ia IIC T1 ... T6 Ga/Gb] Zone 1 gas [II 2G Ex ia IIC T1 ... T6 Gb] Zone 20 dust [II 1D Ex ia IIIC T125 ... T65 °C Da] Zone 21 mounting to zone 20 dust [II 1/2D Ex ia IIIC T125 ... T65 °C Da/Db] Zone 21 dust [II 2D Ex ia IIIC T125 ... T65 °C Db] - Ex e Zone 1 gas [II 2G Ex eb IIC T1 ... T6 Gb] Zone 2 gas [II 3G Ex ec IIC T1 ... T6 Gc] Zone 21 dust [II 2D Ex tb IIIC TX °C Db] Zone 22 dust [II 3D Ex tc IIIC TX °C Dc] - Ex n Zone 2 gas [II 3G Ex nA IIC T1 ... T6 Gc] Zone 22 dust [II 3D Ex tc IIIC TX °C Dc] 	European Union
 	IECEx (option) - in conjunction with ATEX Hazardous areas <ul style="list-style-type: none"> - Ex i Zone 0 gas [Ex ia IIC T1 ... T6 Ga] Zone 1 mounting to zone 0 gas [Ex ia IIC T1 ... T6 Ga/Gb] Zone 1 gas [Ex ia IIC T1 ... T6 Gb] Zone 20 dust [Ex ia IIIC T125 ... T65 °C Da] Zone 21 mounting to zone 20 dust [Ex ia IIIC T125 ... T65 °C Da/Db] Zone 21 dust [Ex ia IIIC T125 ... T65 °C Db] 	International
	EAC (option) Hazardous areas <ul style="list-style-type: none"> - Ex i Zone 0 gas [0 Ex ia IIC T6 ... T1 Ga X] Zone 1 gas [1 Ex ia IIC T6 ... T1 Gb X] Zone 20 dust [Ex ia IIIC T80 ... T440 °C Da X] Zone 21 dust [Ex ia IIIC T80 ... T440 °C Db X] - Ex n Zone 2 gas [Ex nA IIC T6 ... T1 Gc X] 	Eurasian Economic Community
	INMETRO (option) Hazardous areas <ul style="list-style-type: none"> - Ex i Zone 0 gas [Ex ia IIC T3 ... T6 Ga] Zone 1 mounting to zone 0 gas [Ex ia IIC T3 ... T6 Ga/Gb] Zone 1 gas [Ex ia IIC T3 ... T6 Gb] Zone 20 dust [Ex ia IIIC T125 ... T65 °C Da] Zone 21 mounting to zone 20 dust [Ex ia IIIC T125 ... T65 °C Da/Db] Zone 21 dust [Ex ia IIIC T125 ... T65 °C Db] 	Brazil

1) Only for built-in transmitter

Logo	Description	Country
	NEPSI (option) Hazardous areas - Ex i Zone 0 gas [Ex ia IIC T1 ~ T6 Ga] Zone 1 mounting to zone 0 gas [Ex ia IIC T1 ~ T6 Ga/Gb] Zone 1 gas [Ex ia IIC T1 ~ T6 Gb]	China
	KCs - KOSHA (option) Hazardous areas - Ex i Zone 0 gas [Ex ia IIC T4 ... T6] Zone 1 gas [Ex ib IIC T4 ... T6]	South Korea
-	PESO (option) Hazardous areas - Ex i Zone 0 gas [Ex ia IIC T1 ... T6 Ga] Zone 1 mounting to zone 0 gas [Ex ia IIC T1 ... T6 Ga/Gb] Zone 1 gas [Ex ia IIC T1 ... T6 Gb]	India
	DNOP - MakNII (option) Hazardous areas - Ex i Zone 0 gas [II 1G Ex ia IIC T3 ... T6 Ga] Zone 1 mounting to zone 0 gas [II 1/2G Ex ia IIC T3 ... T6 Ga/Gb] Zone 1 gas [II 2G Ex ia IIC T3 ... T6 Gb] Zone 20 dust [II 1D Ex ia IIIC T125 ... T65 °C Da] Zone 21 mounting to zone 20 dust [II 1/2D Ex ia IIIC T125 ... T65 °C Da/Db] Zone 21 dust [II 2D Ex ia IIIC T125 ... T65 °C Db]	Ukraine
	GOST (option) Metrology, measurement technology	Russia
	KazInMetr (option) Metrology, measurement technology	Kazakhstan
-	MTSCHS (option) Permission for commissioning	Kazakhstan
	BelGIM (option) Metrology, measurement technology	Belarus
	UkrSEPRO (option) Metrology, measurement technology	Ukraine
	Uzstandard (option) Metrology, measurement technology	Uzbekistan

Manufacturer's information and certificates

Logo	Description
	SIL 2 Functional safety (only in conjunction with model T32 temperature transmitter)
	NAMUR NE24 Hazardous areas (Ex i)

Instruments marked with "ia" may also be used in areas only requiring instruments marked with "ib" or "ic".
If an instrument with "ia" marking has been used in an area with requirements in accordance with "ib" or "ic", it can no longer be operated in areas with requirements in accordance with "ia" afterwards.

Approvals and certificates, see website

Sensor

Thermocouple per IEC 60584-1 or ASTM E230

Types K, J, N (single or dual thermocouple)

Measuring point

- Ungrounded (standard)
- Welded to the bottom (grounded)

Sensor types

Type	Operating temperatures of the thermocouple			
	IEC 60584-1		ASTM E230	
	Class 2	Class 1	Standard	Special
K	-40 ... +1,200 °C	-40 ... +1,000 °C	0 ... 1,260 °C	
J	-40 ... +750 °C	-40 ... +750 °C	0 ... 760 °C	
N	-40 ... +1,200 °C	-40 ... +1,000 °C	0 ... 1,260 °C	

The table shows the temperature ranges listed in the respective standards, in which the tolerance values (class accuracies) are valid.

The actual operating temperature of the thermometer is limited both by the maximum permissible working temperature and the diameter of the thermocouple and the sheathed cable, as well as by the maximum permissible working temperature of the protection tube material.

For detailed specifications for thermocouples, see IEC 60584-1 or ASTM E230 and Technical information IN 00.23 at www.wika.com.

Tolerance value

For the tolerance value of thermocouples, a cold junction temperature of 0 °C has been taken as the basis.

Electrical connection

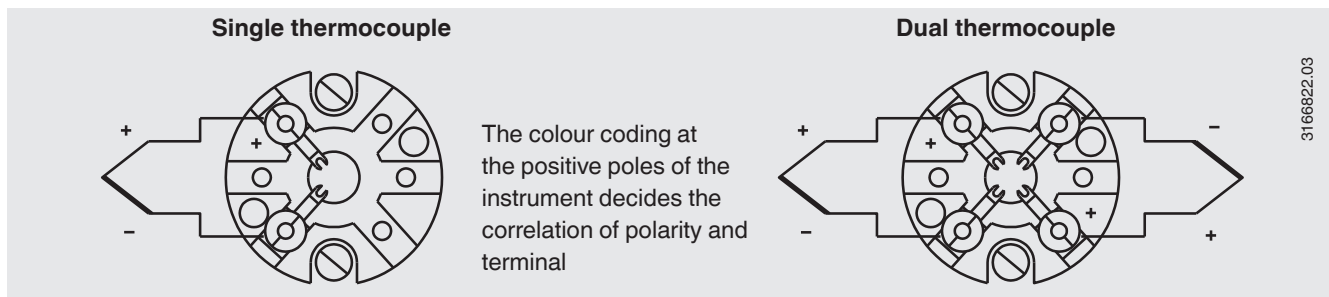

For the electrical connections of built-in temperature transmitters see the corresponding data sheets or operating instructions.

Measuring insert

The measuring insert is made of a vibration-resistant, sheathed measuring cable (MI cable).

Using two screws and springs, the measuring insert can be mounted into a connection head (form B), replaceable and mounted spring-loaded.

When fitting the measuring insert into a protection tube, it is very important to determine the correct insertion length (= protection tube length for bottom thicknesses of ≤ 5.5 mm). In order to ensure that the measuring insert is firmly pressed down onto the bottom of the protection tube, the insert must be spring-loaded (spring travel: max 10 mm).

The standard material used for the measuring insert sheath is Inconel 600 (2.4816). Other materials on request.

Components, model TC81 (with model TW81 protection tube)

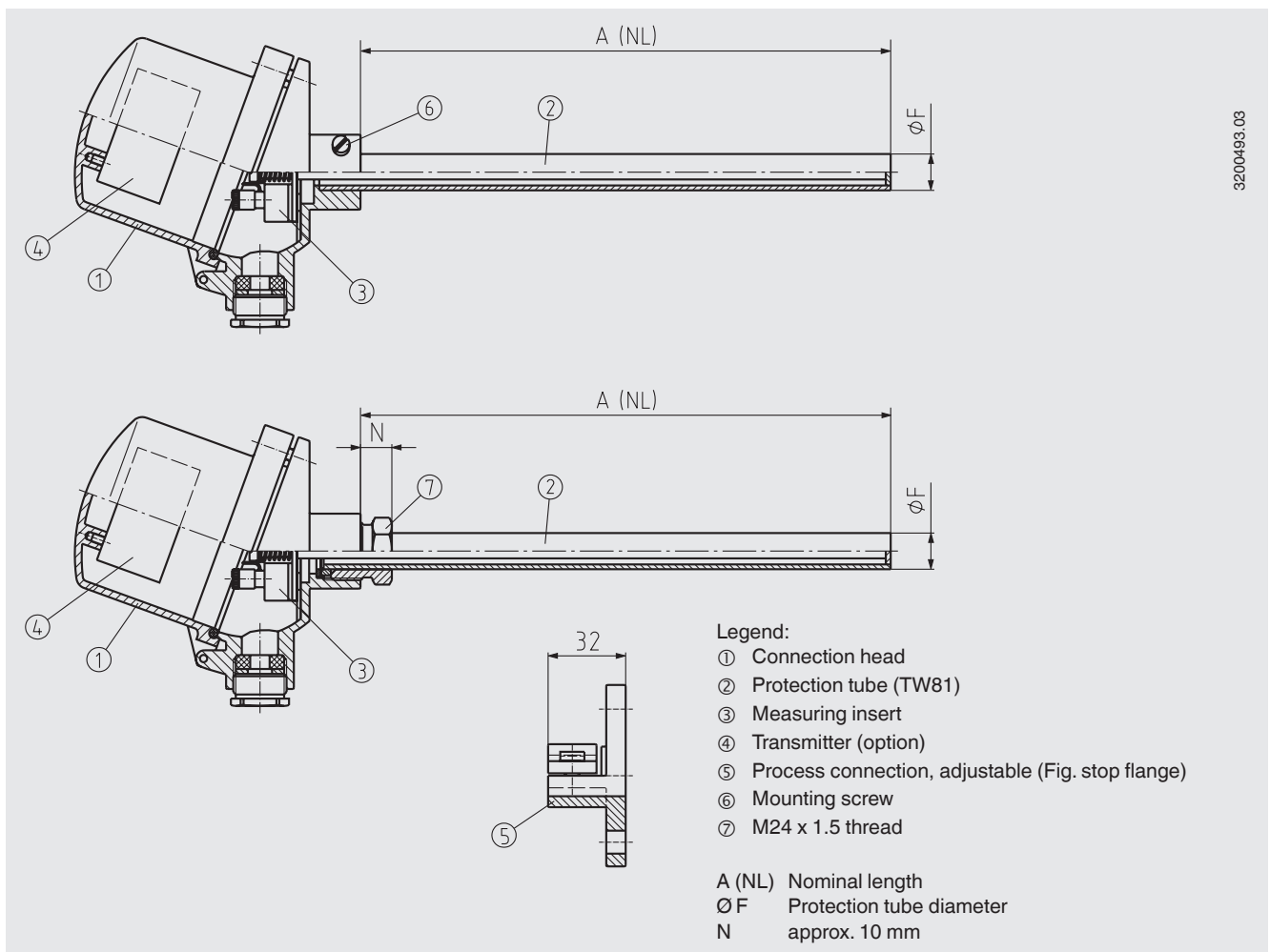

Connection head

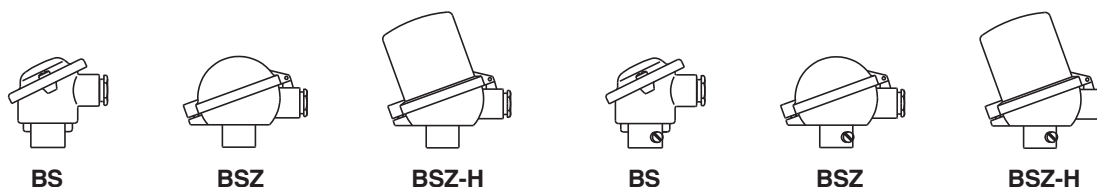

Type	Material	Cable entry thread size	Ingress protection ¹⁾	Cap	Surface
BS	Aluminium	M20 x 1.5	IP53, IP65	Cap with 2 screws	Blue, lacquered ²⁾
BSZ	Aluminium	M20 x 1.5	IP53, IP65	Hinged cover with cylinder head screw	Blue, lacquered ²⁾
BSZ-H	Aluminium	M20 x 1.5	IP53, IP65	Hinged cover with cylinder head screw	Blue, lacquered ²⁾

1) IP53: Lateral mounting screws

IP65: M24 x 1.5 thread

2) RAL 5022

Transmitter (option)

The transmitter can be mounted directly into the thermometer. Attention must be paid to the permissible ambient temperature of the transmitter in accordance with the data sheet. With a direct connection of the thermocouple to the transmitter - due to the heat transfer of the thermocouple wires - the risk of an unacceptably high heating of the transmitter connection terminals increases. For this reason, we recommend installing the transmitter in the cover of a model BSZ-H connection head. Here, the thermocouple is connected indirectly to the transmitter by means of compensating cable between terminal socket and transmitter.

- Mounted within the cover of the connection head
- Mounting is not recommended, on thermal grounds

Connection head	Transmitter model			
	T16	T32	T53	T91.10
BS	-	-	-	-
BSZ	-	-	-	-
BSZ-H	●	●	●	●

Model	Description	Data sheet
T16	Digital transmitter, PC configurable	TE 16.01
T32	Digital transmitter, HART® protocol	TE 32.04
T53	Digital transmitter, FOUNDATION™ Fieldbus and PROFIBUS® PA	TE 53.01
T91.10	Analogue transmitter, fixed measuring range	TE 91.01

Protection tube, model TW81

Metal protection tube

The protection tube is manufactured from tube. The bottom of the protection tube is flat or dished, always dished with enamelled metal protection tube. The protection tube is pressed into the connection head and clamped.

In addition, we offer the possibility of a head screwed onto the protection tube. This enables IP65 protection to be achieved. An adjustable process connection is clamped onto the protection tube, thus allowing a variable insertion length.

Standard nominal lengths per DIN EN 50446 are preferable.

Standard nominal lengths

A = 500, 710, 1,000, 1,400, 2,000 mm

Others on request

Protection tube materials

- Steel 1.0305, unalloyed
up to 550 °C (air), low resistance to sulphurous gases, medium resistance to nitrogen-containing gases
- Steel 1.0305 unalloyed, enamelled
up to 550 °C, can be pressurised up to max. 1 bar, for the low pressure range in furnaces and flue gas ducts
- Stainless steel 1.4571
up to 700 °C (air), good resistance to aggressive media
- Stainless steel 1.4841
up to 1,150 °C (air), low resistance to sulphurous gases; high resistance to nitrogen-containing gases with low oxygen content; high creep strength
- Stainless steel 1.4762
up to 1,200 °C (air), high resistance to sulphurous gases; low resistance to nitrogen-containing gases

Other materials on request

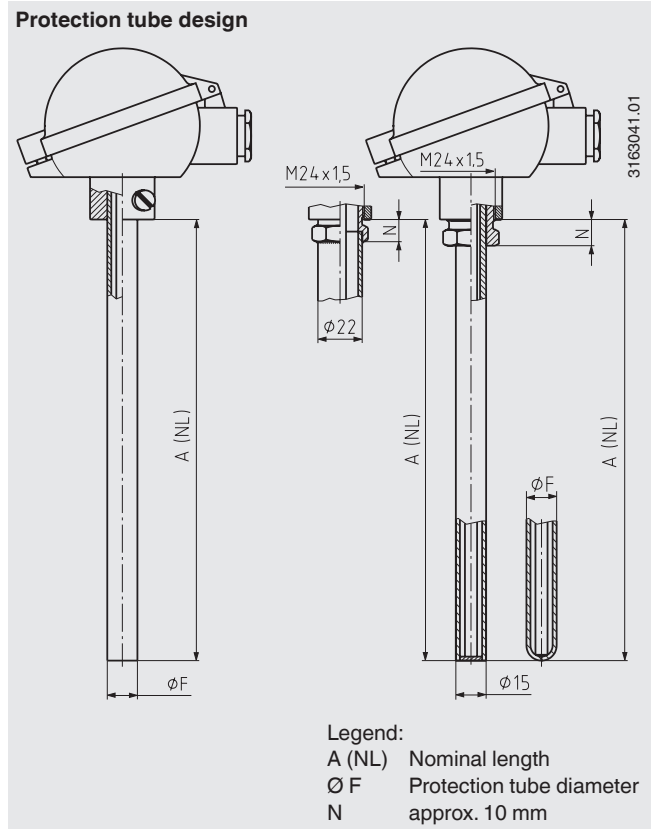

Dimensions in mm

Metal protection tube	
Outer diameter	Wall thickness
Ø F	s
22	2
15	2

Remarks on the selection and operation of metal protection tubes

The following table does not claim to be complete.
All information is non-binding and does not represent guaranteed characteristics. They should be fully tested by the customer using the conditions of the respective application.

Please note:

The maximum operating temperature is limited by the maximum range of application of the sensor.

Resistance when in contact with gases

Material No.	AISI No.	Can be used in air up to °C	Resistance against			
			Sulphurous gases		Nitrogen-containing gases with low oxygen content	Carburisation
			Oxidising	Reducing		
1.0305		550	low	slight	medium	slight
1.4571	316 Ti	800	slight	slight	medium	medium
1.4762		1,200	very high	high	slight	medium
1.4841	310 / 314	1,150	very slight	very slight	high	slight

Operation in gases

Material No.	Range of applications
1.0305 (St35.8)	Tempering furnaces for heat treatment plants, galvanising and tinning plants, carbon-dust-air mixture pipelines in steam power stations
1.0305 enamelled (St35.8 enamelled)	Flue-gas desulphurisation plants, babbitt metal, lead and tin smelters
1.4762 X 10 CrAlSi 25	Combustion exhaust gases, cement and ceramic furnaces, heat treatment plants, annealing furnaces
1.4749 X 18 CrNi 28	Exhaust gas ducts, annealing furnaces
1.4841 X 15 CrNiSi 25-21	Combustion chambers, industrial furnaces, petrochemical industry, hot blast stoves, cyanide baths

Operation in melting plants

Material No.	Range of applications	
1.0305	Babbitt metal	to 600 °C
	Lead	to 700 °C
	Zinc	to 480 °C
	Tin	to 650 °C
1.4841	Aluminium	to 700 °C
	Lead	to 700 °C
	Copper-zinc alloy	to 900 °C
1.4762	Zinc	to 480 °C
	Copper	to 1,250 °C

Process connection

Not gas-tight

A stop flange is sufficient; a mating flange is not needed. The stop flange is adjustable on the protection tube and is secured using a clamp. Therefore, the insertion length of the thermometer is variable and can be easily adjusted at the mounting point.

Gas-tight up to 1 bar

A threaded bushing or a combination of stop flange - mating flange is needed.

- Threaded bushing
 - This is secured onto the metal protection tube using a clamp. Once loosened, adjustment along the protection tube is possible. The insertion length of the thermometer is variable and can be easily adjusted at the mounting point.
- Stop flange - mating flange
 - Sealing is made via gland packing between mating flange and protection tube. It is secured using a clamp between the stop flange and protection tube.
 - The insertion length of the thermometer is variable.

Enamelled protection tube

When using enamelled protection tubes, a threaded bushing should be used to prevent the enamel layer from being damaged.

Mounting example:

Thermocouple with metal protection tube

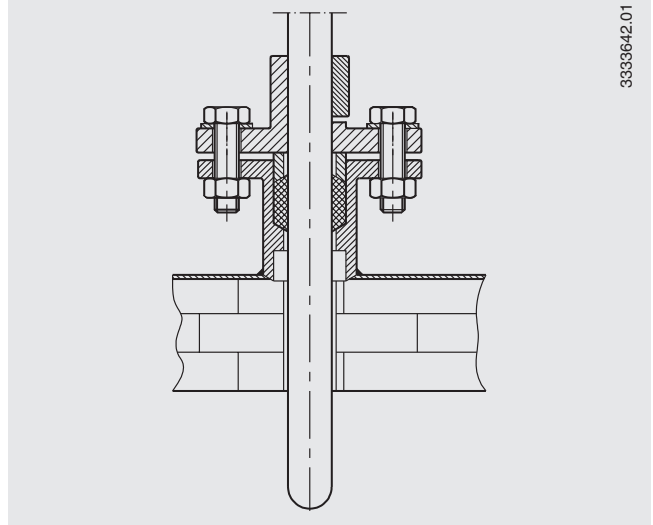

3333642.01

Threaded bushing
adjustable, gas-tight
up to 1 bar
Sealing: Asbestos-free,
up to max. 300 °C
higher temperatures on
request

3163067.04

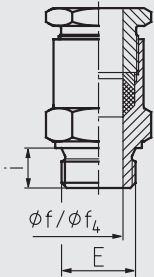

Material:
Carbon steel or
1.4571 stainless steel

Stop flange
per DIN EN 50446
adjustable

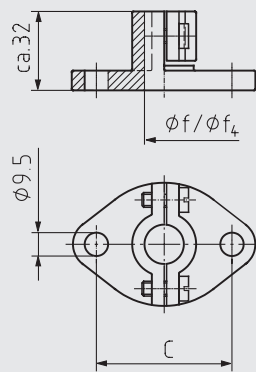

Material:
Carbon steel or malleable cast iron,
others on request

A mating flange can only be used in conjunction with a stop flange
adjustable, gas-tight up to 1 bar
Sealing: Asbestos-free

3163059.04

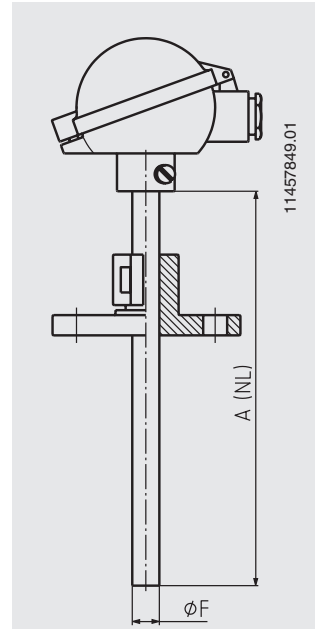
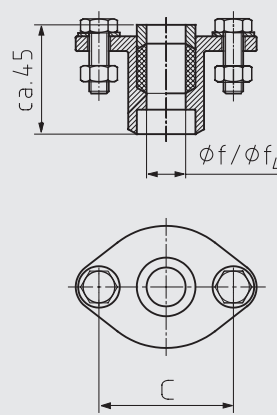

11457849.01

Selectable threaded bushings

Protection tube	Dimensions in mm		Process connection
External ϕ	$\phi f / f_4$	i min.	E
22	22.5	20	G 1, 1 G 1½
15	15.5	20	G ½, G ¾, G 1

Selectable stop flanges

Protection tube	Dimensions in mm	
External ϕ	$\phi f / f_4$	C (hole)
22	22.5	70
15	15.5	55

Other threads on request

Flange connection welded to protection tube

1141723.01

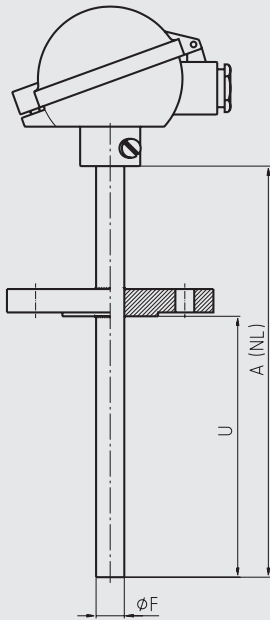

Selectable flange sizes

Flange diameter	Material
1 ½ inch, 150 lbs, RF	Stainless steel 316
1 ½ inch, 300 lbs, RF	Stainless steel 316
2 inch, 150 lbs, RF	Stainless steel 316
2 inch, 300 lbs, RF	Stainless steel 316
3 inch, 150 lbs, RF	Stainless steel 316
3 inch, 300 lbs, RF	Stainless steel 316
4 inch, 150 lbs, RF	Stainless steel 316
4 inch, 300 lbs, RF	Stainless steel 316

Other flange sizes on request

Ordering information

Model / Sensor / Connection head / Transmitter / Certificates / Options

© 08/2004 WIKA Alexander Wiegand SE & Co. KG, all rights reserved.
 The specifications given in this document represent the state of engineering at the time of publishing.
 We reserve the right to make modifications to the specifications and materials.

