

Indoor/outdoor resistance thermometer Model TR60

WIKA data sheet TE 60.60



for further approvals
see page 2

Applications

- Ambient temperature measurement
- Air-conditioned rooms, cold-storage rooms, storehouses, grain storages, malting floors etc.

Special features

- Sensor ranges from $-40 \dots +80 \text{ }^{\circ}\text{C}$ ($-40 \dots +176 \text{ }^{\circ}\text{F}$)
- Transmitter optionally available
- Impact-resistant plastic case
- Explosion-protected versions



Fig. left: outdoor resistance thermometer

Fig. right: indoor resistance thermometer

Description

Outdoor resistance thermometer

This version features a closed sensor tube and is intended for damp or humid rooms and outdoor applications. For application in hazardous areas, intrinsically safe versions are available.

Indoor resistance thermometer

This version is intended for dry rooms. The sensor tube around the sensor is perforated. As a result of this perforation, the sensor is in direct contact with the ambient air. This considerably improves the response time.









The range of applications is enhanced by the addition of optional analogue or digital transmitters.

Explosion protection (option, only for outdoor resistance thermometer)

The permissible power, P_{max} , as well as the permissible ambient temperature, for the respective category can be seen on the EC-type examination certificate, the certificate for hazardous areas or in the operating instructions.





Built-in transmitters have their own EC-type examination certificate. The permissible ambient temperature ranges of the built-in transmitters can be taken from the corresponding transmitter approval. The system operator is responsible for using suitable thermowells.

Approvals (explosion protection, further approvals)

Logo	Description	Country
 	EU declaration of conformity <ul style="list-style-type: none"> ■ EMC directive ¹⁾ EN 61326 emission (group 1, class B) and immunity (industrial application) ■ RoHS directive ■ ATEX directive (option) ²⁾ Hazardous areas - Ex i Zone 1 gas [II 2G Ex ia IIC T1 ... T6 Gb] Zone 21 dust [II 2D Ex ia IIIC T125 ... T65 °C Db] 	European Union
	IECEx (option) ²⁾ (in conjunction with ATEX) Hazardous areas - Ex i Zone 1 gas [Ex ia IIC T1 ... T6 Gb] Zone 21 dust [Ex ia IIIC T125 ... T65 °C Db]	International
	EAC (option) ²⁾ Hazardous areas - Ex i Zone 1 gas [1 Ex ib IIC T3/T4/T5/T6] Zone 21 dust [DIP A21 Ta 65 °C/Ta 95 °C/Ta 125 °C]	Eurasian Economic Community
	INMETRO (option) ²⁾ Hazardous areas - Ex i Zone 1 gas [Ex ib IIC T3 ... T6 Gb] Zone 21 dust [Ex ib IIIC T125 ... T65 °C Db]	Brazil
	NEPSI (option) ²⁾ Hazardous areas - Ex i Zone 1 gas [Ex ib IIC T3 ~ T6]	China
	KCS - KOSHA (option) ²⁾ Hazardous areas - Ex i Zone 1 gas [Ex ib IIC T4 ... T6]	South Korea
-	PESO (option) ²⁾ Hazardous areas - Ex i Zone 1 gas [Ex ib IIC T3 ... T6 Gb]	India
	DNOP - MakNII (option) ²⁾ Hazardous areas - Ex i Zone 21 dust [II 2D Ex ib IIIC T125 ... T65 °C Db]	Ukraine

1) Only for built-in transmitter

2) Only for outdoor resistance thermometer

Logo	Description	Country
	GOST (option) Metrology, measurement technology	Russia
	KazInMetr (option) Metrology, measurement technology	Kazakhstan
-	MTSCHS (option) Permission for commissioning	Kazakhstan
	BelGIM (option) Metrology, measurement technology	Belarus
	UkrSEPRO (option) Metrology, measurement technology	Ukraine
	Uzstandard (option) Metrology, measurement technology	Uzbekistan

Instruments marked with "ia" may also be used in areas only requiring instruments marked with "ib" or "ic".
If an instrument with "ia" marking has been used in an area with requirements in accordance with "ib" or "ic", it can no longer be operated in areas with requirements in accordance with "ia" afterwards.

Approvals and certificates, see website

Sensor

Measuring element

Pt100, Pt1000 ¹⁾ (measuring current: 0.1 ... 1.0 mA) ²⁾

Connection method	
Single elements	1 x 2-wire 1 x 3-wire 1 x 4-wire
Dual elements	2 x 2-wire 2 x 3-wire 2 x 4-wire ³⁾

Accuracy class / Range of use of the sensor per EN 60751		
Class	Sensor construction	
	Wire-wound	Thin-film
Class B	-196 ... +600 °C	-50 ... +500 °C
	-196 ... +450 °C	-50 ... +250 °C
Class A ⁴⁾	-100 ... +450 °C	-30 ... +300 °C
Class AA ⁴⁾	-50 ... +250 °C	0 ... 150 °C

- 1) Pt1000 only available as a thin-film measuring resistor
- 2) For detailed specifications for Pt100 sensors, see Technical information IN 00.17 at www.wika.com.
- 3) Not with 3 mm diameter
- 4) Not with 2-wire connection method

The table shows the temperature ranges listed in the respective standards, in which the tolerance values (class accuracies) are valid.

Due to the design, the actual range of use of the resistance thermometer is limited to -40 ... +80 °C.

Electrical connection (colour code per IEC/EN 60751)

Connection terminals located in the case

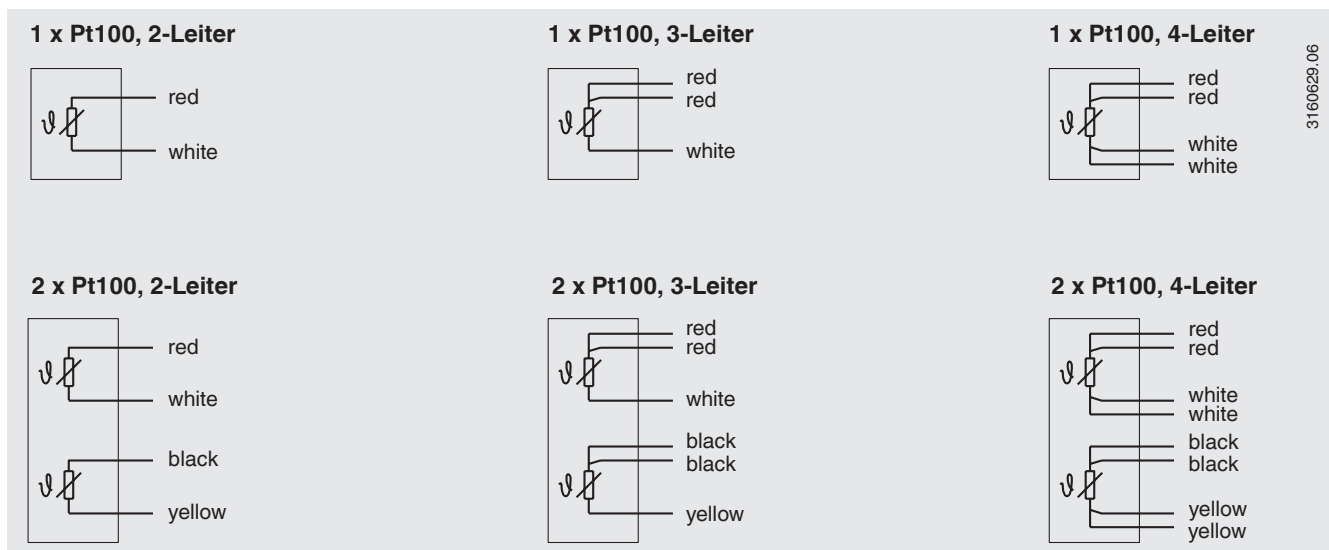

For the electrical connections of built-in temperature transmitters see the corresponding data sheets or operating instructions.

Probe

The standard probe has a 6 mm diameter and is available with 1 x Pt100 or 2 x Pt100 in 2-wire, 3-wire or 4-wire circuit.

Specifications

Specifications	Outdoor resistance thermometer	Indoor resistance thermometer
Sensor		
■ Version	Rigid tube, closed	Rigid tube, perforated in the area of the sensor
■ Material	Stainless steel 1.4571	Stainless steel 1.4571
■ Sensor length	60 mm ¹⁾	60 mm ¹⁾
■ Sensor diameter	6 mm ¹⁾	6 mm ¹⁾
Case		
■ Version	For wall mounting	For wall mounting
■ Material	ABS plastic or aluminium	ABS plastic or aluminium
■ Dimensions	see "Dimensions in mm" ¹⁾	see "Dimensions in mm" ¹⁾
Cable outlet	M16 x 1.5 ¹⁾	M16 x 1.5 ¹⁾
Permissible temperature ranges		
■ Ambient temperature	-40 ... +80 °C ²⁾	-40 ... +80 °C ²⁾
■ Storage temperature	-40 ... +80 °C	-40 ... +80 °C
Ingress protection	IP65 per IEC/EN 60529	IP20 per IEC/EN 60529
Weight	approx. 0.4 kg	approx. 0.4 kg

1) Others on request

2) The working temperature of the indoor resistance thermometer is limited by the permissible ambient temperature of the case.

Transmitter (option)

A transmitter can be mounted into the case. This is done by mounting the transmitter in place of the connection terminals.



Output signal 4 ... 20 mA, HART® protocol, FOUNDATION™ Fieldbus and PROFIBUS® PA			
Transmitter (selectable versions)	Model T15	Model T32	Model T53
Data sheet	TE 15.01	TE 32.04	TE 53.01
Output			
■ 4 ... 20 mA	x	x	
■ HART® protocol		x	
■ FOUNDATION™ Fieldbus and PROFIBUS® PA			x
Connection method			
■ 1 x 2-wire, 3-wire or 4-wire	x	x	x
Measuring current	< 0.2 mA	< 0.3 mA	< 0.2 mA
Explosion protection	Optional	Optional	Standard

Dimensions in mm

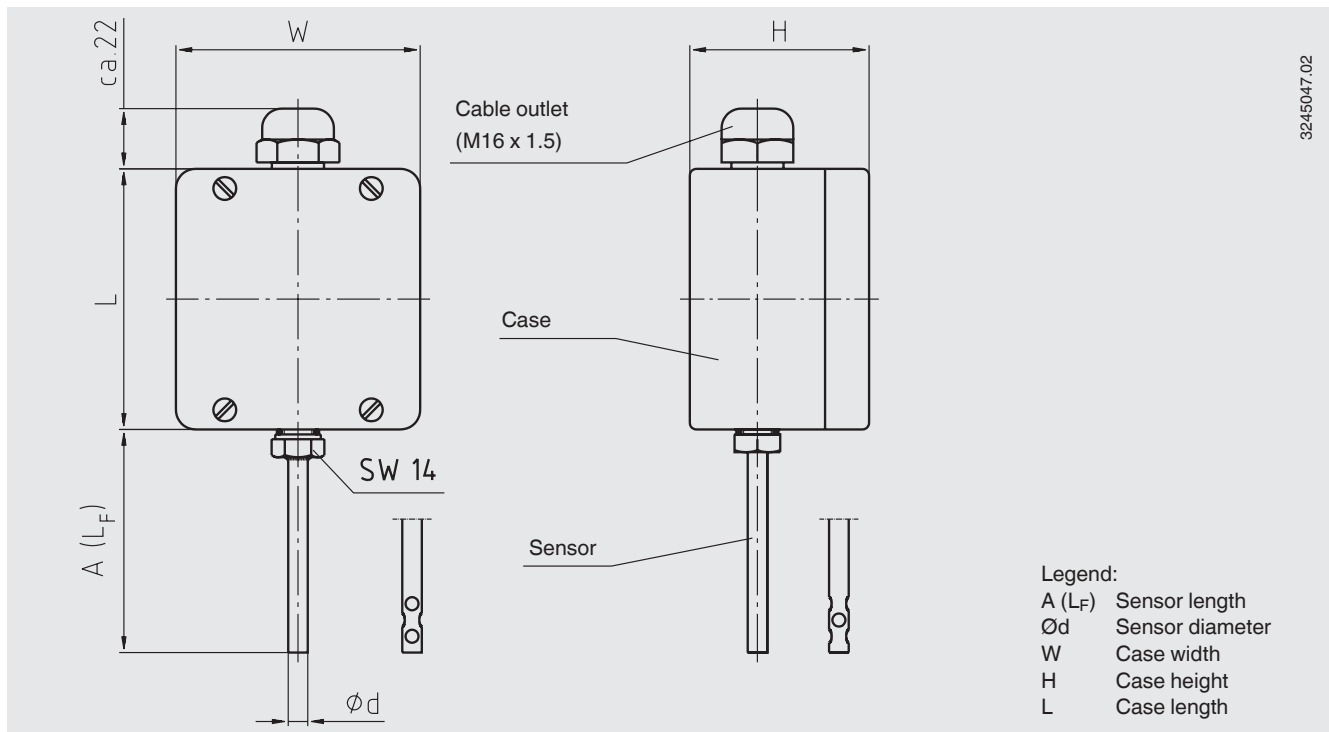

Case	Dimensions in mm				
	L	W	H	A (L _F)	Ød
Plastic (ABS)	82	80	55	60	6
Aluminium	80	75	57	60	6

Certificates (option)

Certification type	Measurement accuracy	Material certificate
2.2 test report	x	x
3.1 inspection certificate	x	x

2) Only for outdoor resistance thermometer

The different certifications can be combined with each other.

Ordering information

Model / Sensor version / Explosion protection / Case / Cable outlet / Terminal block, Transmitter / Sensor material / Sensor diameter / Insertion length / Measuring element / Connection method / Temperature range / Certificates / Options

© 05/2008 WIKA Alexander Wiegand SE & Co. KG, all rights reserved.

The specifications given in this document represent the state of engineering at the time of publishing.
We reserve the right to make modifications to the specifications and materials.

