

# Measuring insert For resistance thermometer Model TR10-A

WIKA data sheet TE 60.01



for further approvals  
see page 2

## Applications

- Replacement measuring insert for servicing
- For all industrial and laboratory applications

## Special features

- Sensor ranges from -196 ... +600 °C [-320 ... +1.112 °F]
- Made of mineral-insulated sheathed cable
- Functional safety (SIL) with model T32 temperature transmitter
- Spring-loaded design
- Explosion-protected versions are available for many approval types (see page 2)



**Fig. left: Standard version**

**Fig. right: Model TR10-A with recessed soldering lugs (option)**

## Description

The measuring inserts per DIN 43735 for resistance thermometers described here are designed for installation in a protective fitting. Operation without a thermowell is only advisable in special cases. The measuring insert is manufactured from bendable, mineral-insulated sheathed cable. The sensor is located in the tip of the measuring insert. The measuring inserts are delivered with loading springs to ensure a good contact to the thermowell floor.

Apart from the DIN versions, customer specific versions are available, for example:

- other measuring insert lengths (also intermediate lengths)
- with mounted sleeve to suit inner diameter of the thermowell
- without terminal block
- with transmitter

Type and number of sensors, accuracy and method of connection can each be selected to suit the respective application.

A large number of different explosion-protected approvals are available for the TR10-A.

The range of applications is completed by designs without terminal block for direct transmitter installation. Optionally, analogue or digital transmitters from the WIKA range can be installed.

## Explosion protection (option)







The permissible power  $P_{max}$  as well as the permissible ambient temperature for the respective category can be seen on the Ex certificate or in the operating instructions.

### Attention:

Depending on the version, the measuring inserts can be used in different ignition protection types when built into model TR10-B, TR10-C, TR10-F or TR81 resistance thermometers. With the correspondingly suitable protective fitting, operation in dust Ex hazardous areas is possible.

The use of a model TR10-A measuring insert is not permitted in hazardous areas without a suitable protective housing!

## Approvals (explosion protection, further approvals)







Logo	Description	Country
 	<b>EU declaration of conformity</b> <ul style="list-style-type: none"> <li>■ EMC directive <sup>1)</sup> EN 61326 emission (group 1, class B) and interference immunity (industrial application)</li> <li>■ RoHS directive</li> <li>■ ATEX directive (option) Hazardous areas           <ul style="list-style-type: none"> <li>- Ex i Zone 0 gas II 1G Ex ia IIC T1 ... T6 Ga</li> <li>Zone 1 gas II 2G Ex ia IIC T1 ... T6 Gb</li> <li>- Ex e <sup>2)</sup> Zone 1 gas II 2G Ex eb IIC T1 ... T6 Gb <sup>4)</sup></li> <li>Zone 2 gas II 3G Ex ec IIC T1 ... T6 Gc X</li> <li>- Ex n <sup>2)</sup> Zone 2 gas II 3G Ex nA IIC T1 ... T6 Gc X</li> </ul> </li> </ul>	European Union
	<b>IECEx (option) - in conjunction with ATEX</b> Hazardous areas <ul style="list-style-type: none"> <li>- Ex i Zone 0 gas Ex ia IIC T1 ... T6 Ga</li> <li>Zone 1 gas Ex ia IIC T1 ... T6 Gb</li> <li>- Ex e <sup>3)</sup> Zone 1 gas Ex eb IIC T1 ... T6 Gb <sup>4)</sup></li> <li>Zone 2 gas Ex ec IIC T1 ... T6 Gc</li> <li>- Ex n <sup>3)</sup> Zone 2 gas Ex nA IIC T1 ... T6 Gc</li> </ul>	International
	<b>EAC (option)</b> Hazardous areas <ul style="list-style-type: none"> <li>- Ex i Zone 0 gas 0Ex ia IIC T6 ... T1 Ga X</li> <li>- Ex n Zone 2 gas 2Ex nA IIC T6 ... T1 Gc X</li> </ul>	Eurasian Economic Community
	<b>Ex Ukraine (option)</b> Hazardous areas <ul style="list-style-type: none"> <li>- Ex i Zone 0 gas II 1G Ex ia IIC T1...T6 Ga</li> </ul>	Ukraine
	<b>INMETRO (option)</b> Hazardous areas <ul style="list-style-type: none"> <li>- Ex i Zone 0 gas Ex ia IIC T3 ... T6 Ga</li> </ul>	Brazil
	<b>CCC (option)</b> Hazardous areas <ul style="list-style-type: none"> <li>- Ex i Zone 0 gas Ex ia IIC T1 ~ T6 Ga</li> <li>- Ex e <sup>3)</sup> Zone 2 gas Ex e IIC T1 ~ T6 Gb <sup>4)</sup></li> <li>- Ex n <sup>3)</sup> Zone 2 gas Ex nA IIC T1 ~ T6 Gc</li> </ul>	China

1) Only for built-in transmitter

2) Only in combination with connection head model BSZ, BSZ-H, 1/4000, 5/6000 or 7/8000

3) Only in combination with connection head model 1/4000, 5/6000 or 7/8000

4) Without transmitter

Logo	Description	Country
	<b>KCs - KOSHA (option)</b> Hazardous areas - Ex i      Zone 0 gas      Ex ia IIC T4 ... T6 Zone 1 gas      Ex ib IIC T4 ... T6	South Korea
-	<b>PESO (option)</b> Hazardous areas - Ex i      Zone 0 gas      Ex ia IIC T1 ... T6 Ga Zone 1 gas      Ex ia IIC T1 ... T6 Gb	India
	<b>GOST (option)</b> Metrology, measurement technology	Russia
	<b>KazInMetr (option)</b> Metrology, measurement technology	Kazakhstan
-	<b>MTSCHS (option)</b> Permission for commissioning	Kazakhstan
	<b>BelGIM (option)</b> Metrology, measurement technology	Belarus
	<b>UkrSEPRO (option)</b> Metrology, measurement technology	Ukraine
	<b>Uzstandard (option)</b> Metrology, measurement technology	Uzbekistan

## Manufacturer's information and certifications

Logo	Description
	<b>NAMUR NE 024</b> Hazardous areas (Ex i)

Instruments marked with "ia" may also be used in areas only requiring instruments marked with "ib" or "ic".  
If an instrument with "ia" marking has been used in an area with requirements in accordance with "ib" or "ic", it can no longer be operated in areas with requirements in accordance with "ia" afterwards.

Approvals and certificates, see website

# Sensor

## Measuring element

Pt100 (measuring current: 0.1 ... 1.0 mA) <sup>1)</sup>

Connection method	
Single elements	1 x 2-wire 1 x 3-wire 1 x 4-wire
Dual elements	2 x 2-wire 2 x 3-wire 2 x 4-wire <sup>2)</sup>

Validity limits of class accuracy per EN 60751		
Class	Sensor construction	
	Wire-wound	Thin-film
Class B	-196 ... +600 °C	-50 ... +500 °C
Class A <sup>3)</sup>	-100 ... +450 °C	-30 ... +300 °C
Class AA <sup>3)</sup>	-50 ... +250 °C	0 ... 150 °C

1) For detailed specifications for Pt100 sensors, see Technical information IN 00.17 at [www.wika.com](http://www.wika.com).  
 2) Not with 3 mm diameter  
 3) Not for 2-wire connection method

The table shows the temperature ranges listed in the respective standards, in which the tolerance values (class accuracies) are valid.

## Electrical connection (colour code per IEC/EN 60751)

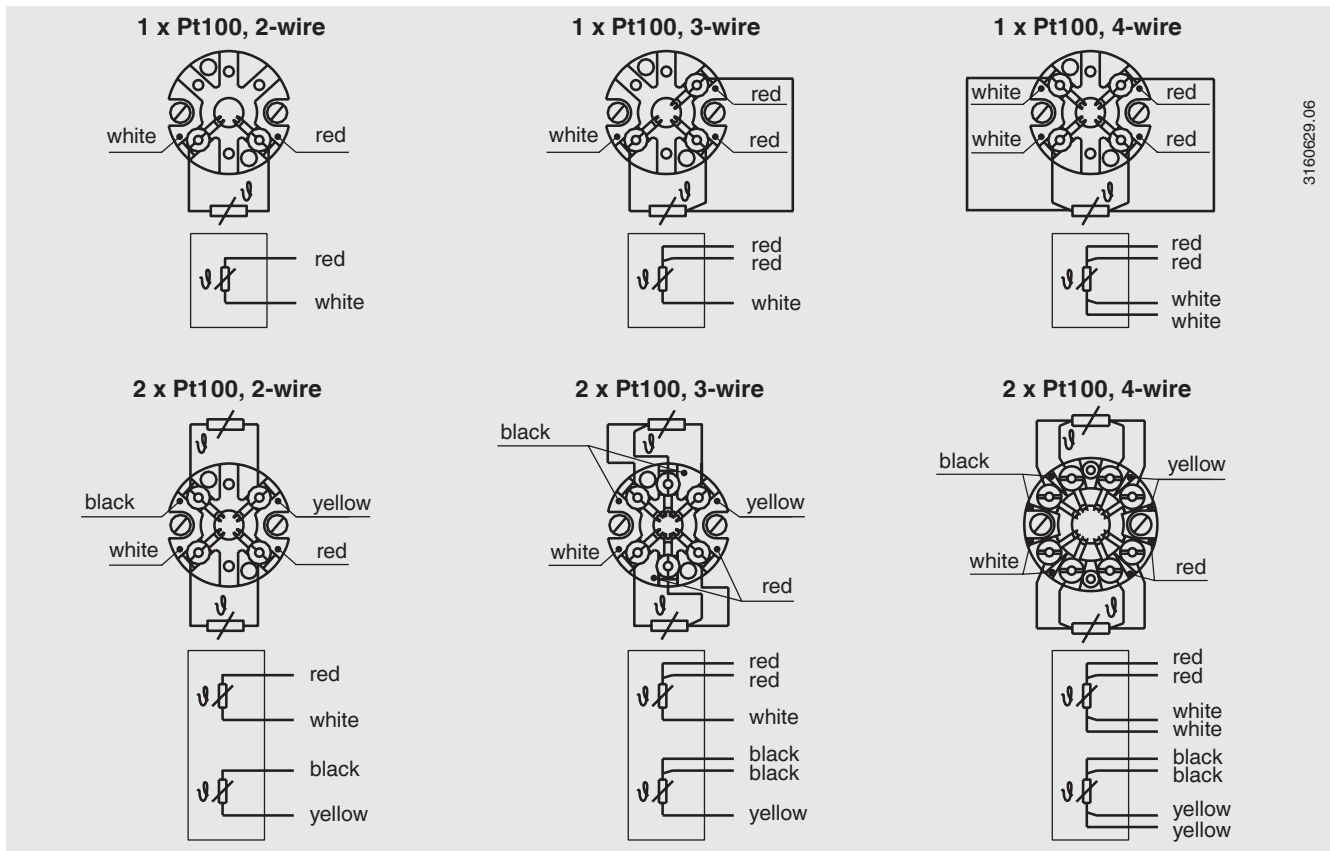

For the electrical connections of built-in temperature transmitters see the corresponding data sheets or operating instructions.

## Transmitter (option)

A transmitter can be built upon the measuring insert. In this case, the transmitter replaces the terminal block and is directly attached to the terminal plate of the measuring insert. The temperature transmitter should be protected from temperatures over 85 °C.



Output signal 4 ... 20 mA, HART® protocol		
Transmitter (selectable versions)	Model T15	Model T32
Data sheet	TE 15.01	TE 32.04
<b>Output</b>		
4 ... 20 mA	x	x
HART® protocol	-	x
<b>Connection method</b>		
1 x 2-wire, 3-wire or 4-wire	x	x
<b>Measurement current</b>	< 0.2 mA	< 0.3 mA

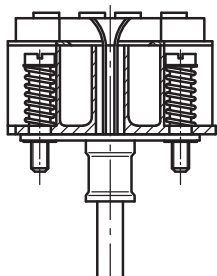

Measuring insert with mounted transmitter  
(here: model T32)

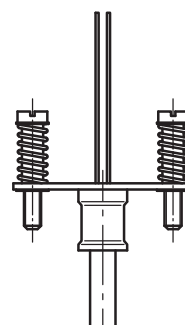

Measuring insert prepared for transmitter mounting

## Functional safety (option) with temperature transmitter model T32



In safety-critical applications, the entire measuring chain must be taken into consideration in terms of the safety parameters. The SIL classification allows the assessment of the risk reduction reached by the safety installations.

Selected TR10-A measuring inserts in combination with a suitable temperature transmitter (e.g. model T32.1S, TÜV certified SIL version for protection systems developed in accordance with IEC 61508) are suitable as sensors for safety functions to SIL 2.

Matched thermowells allow easy dismounting of the measuring insert for calibration. The optimally matched measuring point consists of a thermowell, a thermometer with built-in TR10-A measuring insert and a T32.1S transmitter developed in accordance with IEC 61508. Thus, the measuring point provides maximum reliability and a long service life.

## Dimensions in mm

The replaceable measuring insert is made of a vibration-resistant, sheathed, mineral-insulated cable (MI cable).

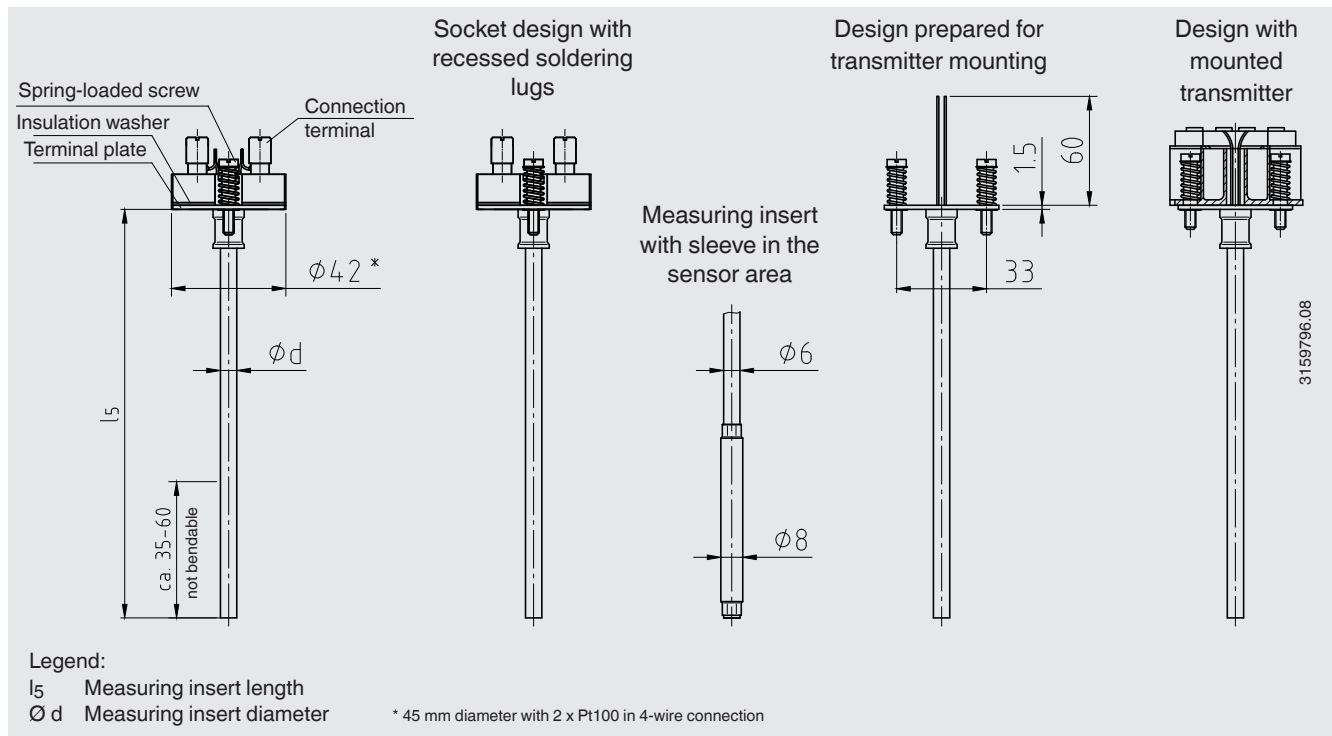

Measuring insert length $l_5$ in mm	Tolerance in mm
75 ... 825	+2 0
> 825	+3 0

### Please note:

Measuring inserts from a length of 1,100 mm are delivered wound in a ring shape.

Only on explicit request do we deliver measuring inserts with lengths of greater than 1,100 mm in a stretched, straight form. To specify this in the order, please contact your WIKA contact person.

Measuring insert diameter $\phi d$ in mm	Index per DIN 43735	Tolerance in mm	
3 <sup>1)</sup>	Standard	30	$3 \pm 0.05$
6	Standard	60	$6 \begin{smallmatrix} 0 \\ -0,1 \end{smallmatrix}$
8 (6 mm with sleeve)	Standard	-	$8 \begin{smallmatrix} 0 \\ -0,1 \end{smallmatrix}$
8	Standard	80	$8 \begin{smallmatrix} 0 \\ -0,1 \end{smallmatrix}$
1/8 in [3.17 mm] <sup>1)</sup> 1/4 in [6.35 mm] 3/8 in [9.53 mm]	On request	-	-

1) Not possible with 2 x Pt100, 4-wire

Only correct measuring insert length and correct measuring insert diameter ensure sufficient heat transfer from thermowell to the measuring insert.

The bore diameter of the thermowell should be a max. 1 mm larger than the measuring insert diameter.

Gaps of more than 0.5 mm between thermowell and the measuring insert will have a negative effect on the heat

transfer, and they will result in unfavourable response behaviour from the thermometer.

When fitting the measuring insert into a thermowell, it is very important to determine the correct insertion length (= thermowell length for bottom thicknesses of  $\leq 5.5$  mm). In order to ensure that the measuring insert is firmly pressed down onto the bottom of the thermowell, the insert must be spring-loaded (spring travel: max 10 mm).

## Materials

Material	
Sheath material	Stainless steel 316
	Stainless steel 1.4571

## Certificates (option)

Certification type	Measurement accuracy	Material certificate
2.2 test report	x	x
3.1 inspection certificate	x	x
DKD/DAkkS calibration certificate	x	-

The different certifications can be combined with each other.

The minimum length for carrying out a measurement accuracy test 3.1 or DKD/DAkkS is 100 mm.  
Calibration of shorter lengths on request.

## Operating conditions

### Mechanical requirements

Version (per EN 60751)	
Standard	6 g peak-to-peak, wire-wound or thin film measuring resistor
Option	Vibration resistant sensor tip, max. 20 g peak-to-peak (thin-film measuring resistor)
	Highly vibration resistant sensor tip, max. 50 g peak-to-peak (thin-film measuring resistor)

The information on the vibration resistance refers to the tip of the measuring insert.

### Ambient and storage temperature

-60 <sup>1)</sup> / -40 ... +80 °C

1) Special version on request (explosion-protected versions only available with specific approvals)

Other ambient and storage temperatures on request

### Ingress protection

IP00 per IEC/EN 60529

The measuring inserts for the model TR10-A are designed for mounting into protective components (connection head + protection tube/thermowell).

These protective components feature connection heads/ cable glands/thermowells/protection tubes which ensure a higher IP protection.

## Ordering information

Model / Explosion protection / Ignition protection type / Zone / Sensor / Accuracy class / Application range of the thermometer / Measuring insert length  $l_5$  / Measuring insert diameter  $\varnothing d$  / Sheath material / Mechanical requirements / Certificates / Options

© 09/2003 WIKA Alexander Wiegand SE & Co. KG, all rights reserved.  
The specifications given in this document represent the state of engineering at the time of publishing.  
We reserve the right to make modifications to the specifications and materials.

