

Hand-held thermometer, industrial version Model CTH6300 Model CTH6310, explosion-protected version

WIKA data sheet CT 51.05



for further approvals
see page 3

Applications

- Calibration service companies and service industry
- Measurement and control laboratories
- Industry (laboratory, workshop and production)
- Quality assurance

Special features

- Accuracy to 0.1 K (complete measuring chain)
- One- and two-channel versions
- Connection possibility for various probe types
- Intrinsically safe version, Ex ib IIB T4 Gb



Hand-held thermometer model CTH6300

Description

The all-purpose model CTH6300 hand-held thermometer, for superior mobile temperature measurement, is notable for its flexibility and ease of handling.

In addition to Pt100 resistance thermometers, it can also process signals from typical thermocouples. Thus temperatures from $-200 \dots +1,500 \text{ }^{\circ}\text{C}$ [$-328 \dots +2,732 \text{ }^{\circ}\text{F}$] can be measured.

The explosion-protected version is only available for Pt100 resistance thermometers.

Its design makes it especially suitable for the commissioning, maintenance and service/calibration of temperature instruments and equipment.

Low-drift measuring amplifiers ensure small measurement errors, while easy-to-use adjustment features considerably simplify adjustments and calibrations:

- Calibration by code for fast setting of standard probes via key data
- Physical calibration of probe and display at one, two or three different temperatures

In this way it is possible to reduce measuring errors to a minimum and ensure a high indication accuracy.

Complete test and service cases

For the secure transportation and storage of the instrument and accessories, a rugged service case is available as a sensible addition. The service case can carry one model CTH6300 digital indicator and several temperature probes.

Certified accuracy

For each temperature probe, the accuracy for the complete measuring chain is certified by a factory calibration certificate which accompanies the instrument.

On request, we can provide a DKD/DAkkS calibration certificate for this instrument.







Specifications

Hand-held thermometer	Model CTH6300	Model CTH6310
Probe types	Pt100, thermocouples	Pt100
Measuring inputs	1 or 2	1 or 2
Measuring ranges		
Pt100	-200 ... +600 °C [-328 ... +1,112 °F]	-200 ... +600 °C [-328 ... +1,112 °F]
Thermocouples	-200 ... +1,500 °C [-328 ... + 2,732 °F]	-
Accuracies		
Resistance thermometer type Pt100	0.1 K of -100 ... +200 °C [-148 ... +392 °F] otherwise 0.1 % of reading	0.1 K of -100 ... +200 °C [-148 ... +392 °F] otherwise 0.1 % of reading
Thermocouple types K, J, L, N and T	0.3 K of 0 ... 200 °C [32 ... 392 °F] 1 K of 200 ... 1,000 °C [392 ... 1,832 °F] 1.5 K above 1,000 °C [1,832 °F]	-
Thermocouple types R and S	1 K + 0.1 % of reading	-

Digital indicator	
Indication	
Display	Large 4 1/2-digit LC display with backlighting, for the display of two temperature values and additional information
Resolution	0.1 K
Indication range	-19999 ... 19999
Functions	
Measuring rate	Measuring rate (can be set via menu) ■ 1/s ("slow" - slow measurement) ■ 4/s ("fast" - fast measurement)
Real-time clock	integrated clock with date
Min./Max. memory	Minimum or maximum measured value (can be accessed via function key)
Hold	Holding the last measured value (can be accessed via function key)
Zero point adjustment	Tare or zero point adjustment can be accessed via function key
Voltage supply	
Supply voltage	■ 9 V battery ■ 9 V rechargeable battery or mains supply (not permissible for CTH6310)
Battery life	approx. 20 hours of operation with battery
Permissible ambient conditions	
Ambient temperature	0 ... 40 °C [32 ... 104 °F]
Storage temperature	-10 ... +50 °C [14 ... 122 °F]
Relative humidity	0 ... 95 % r. h. (non-condensing)
Communication	
Serial interface	USB via interface cable
Case	
Material	impact-resistant ABS plastic, transparent screen
Dimensions (L x W x H)	200 x 93 x 44 mm [7.87 x 3.66 x 1.73 in]
Weight	300 g [0.66 lbs.] (incl. battery)

Temperature probe (immersion probe)	
Measuring element	Temperature range
Pt100	<ul style="list-style-type: none"> ■ -200 ... +450 °C [-328 ... +842 °F] ■ -40 ... +500 °C [-40 ... +932 °F]
Type K	-100 ... +1,100 °C [-148 ... +2,012 °F]
Sensor dimensions	
Pt100	<ul style="list-style-type: none"> ■ d = 3 mm, l = 150 mm [d = 0.12 in, l = 5.91 in] ■ d = 3 mm, l = 300 mm [d = 0.12 in, l = 11.81 in] ■ d = 3 mm, l = 1,000 mm [d = 0.16 in, l = 39.37 in] ■ d = 4 mm, l = 300 mm [d = 0.16 in, l = 11.81 in] ■ d = 6 mm, l = 300 mm [d = 0.24 in, l = 11.81 in]
TC K	<ul style="list-style-type: none"> ■ d = 3 mm, l = 300 mm [d = 0.12 in, l = 11.81 in] ■ d = 3 mm, l = 500 mm [d = 0.12 in, l = 19.69 in]
Sensor cable	
Cable length	1,000 mm
Cable material	PVC
Connection to CTH63x0	8-pin, DIN circular connector
Dimensions (L x W x H)	see technical drawing

Approvals

Logo	Description	Country
	EU declaration of conformity for the CTH6300 <ul style="list-style-type: none"> ■ EMC directive EN 61326 emission (group 1, class B) and immunity (portable test and measuring equipment) ■ RoHS directive 	European Union
 	EU declaration of conformity for the CTH6310 <ul style="list-style-type: none"> ■ EMC directive EN 61326 emission (group 1, class B) and immunity (portable test and measuring equipment) ■ RoHS directive ■ ATEX directive - Ex i Zone 1 gas II 2G Ex ib IIB T4 Gb T4 at 0 ... 40 °C 	European Union
	EAC (option) EMC directive	Eurasian Economic Community
	GOST (option) Metrology, measurement technology	Russia
-	MTSCHS (option) Permission for commissioning	Kazakhstan
	KazInMetr (option) Metrology, measurement technology	Kazakhstan
	UkrSEPRO (option) Metrology, measurement technology	Ukraine

Certificates

Certificate	
Calibration	Standard: 3.1 calibration certificate per DIN EN 10204 Option: DKD/DAkkS calibration certificate
Recommended recalibration interval	1 year (dependent on conditions of use)

Approvals and certificates, see website

Dimensions in mm [in]

Hand-held thermometer, models CTH6300 and CTH6310 as explosion-protected version

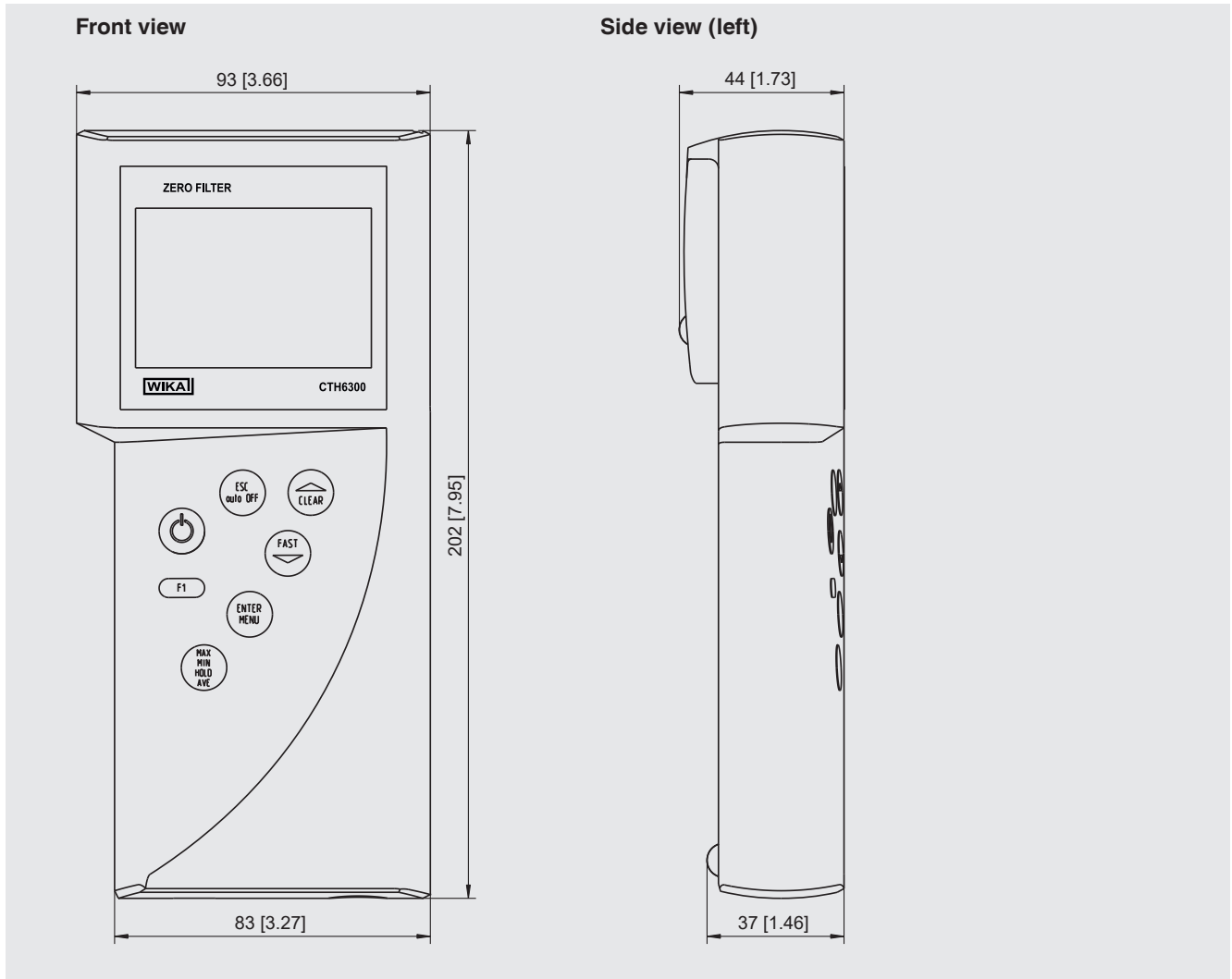

Temperature probe, immersion probe

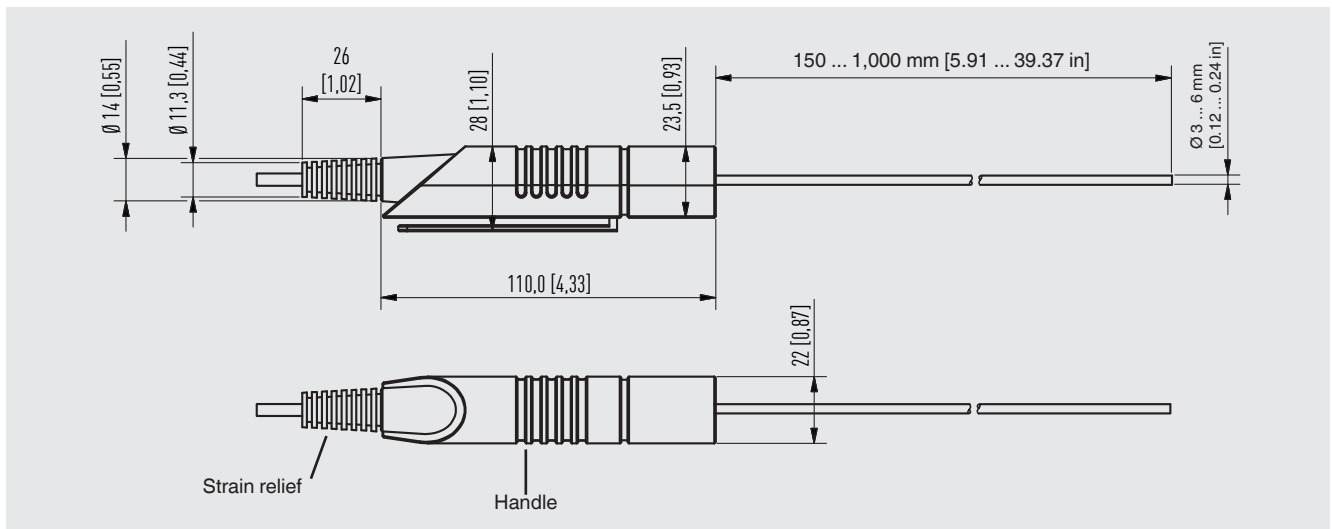

Electrical connections

Model CTH63x0 (1-channel instrument)

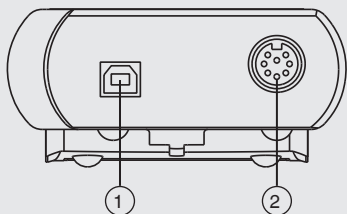

Model CTH63x0 (2-channel instrument)

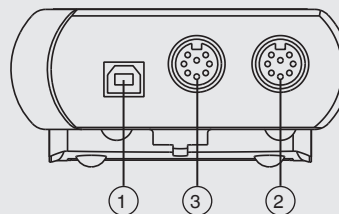

- ① Connection USB interface
- ② Connection temperature probe 1 (only for CTH6300 or CTH6310 with one connection)
- ③ Connection temperature probe 2 (only for CTH6300 or CTH6310 with two connections)

Features of the hand-held thermometer

- Easy handling
- Large display with dual temperature display and bar graph
- Min./Max. value for monitoring of temperature limits
- Mean value function for statistical evaluation
- “Fast mode” for faster measurements up to 4/s
- Selectable channel can be switched off to improve the clarity of the display data
- Recording and visualisation of temperature cycles with the help of the DE-Graph software

- ① Probe holder
- ② First connection port for temperature probe
- ③ Second connection port for temperature probe
- ④ USB connection port for PC
- ⑤ Keyboard
- ⑥ Large LC display



Operation

In the **SETUP** menu, a menu point can be selected and altered using the **UP** and **DOWN** keys. **ENTER** and **ESC** are used for confirmation and exit.

The operating menu is intuitively understandable and is subdivided into only two levels:

Main menu for the selection of the basic functions and parameter menu for setting the parameters.

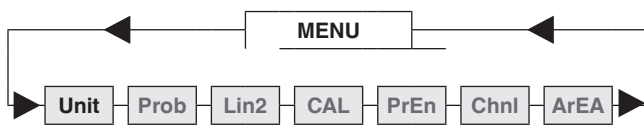

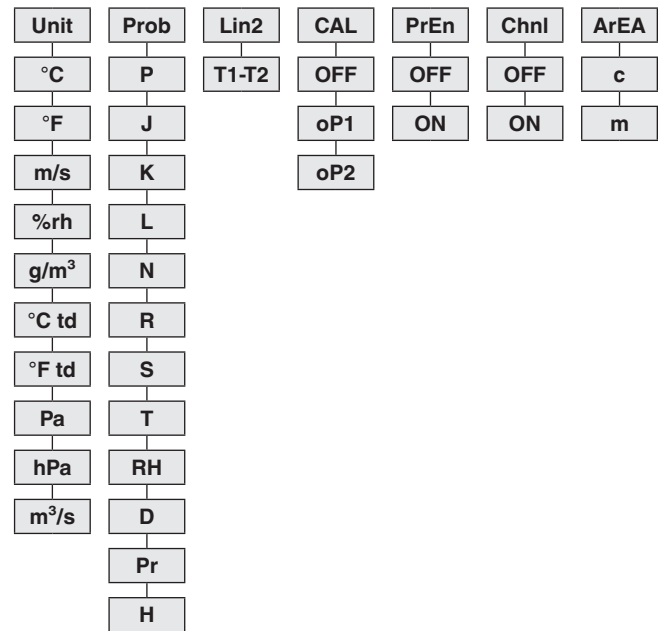

Main menu for CTH6300



Parameter menu for CTH6300



Accessories

Accessories for CTH6300		Order code
Description		CTX-A-H2
	Immersion probe Type Pt100 Dimensions: d = 3 mm, l = 150 mm [d = 0.12 in, l = 5.91 in] Temperature range: -200 ... +450 °C [-328 ... +842 °F]	-10-
	Type Pt100 Dimensions: d = 3 mm, l = 300 mm [d = 0.12 in, l = 11.81 in] Temperature range: -200 ... +450 °C [-328 ... +842 °F]	-20-
	Type Pt100 Dimensions: d = 4 mm, l = 300 mm [d = 0.16 in, l = 11.81 in] Temperature range: -40 ... +500 °C [-40 ... +932 °F]	-40-
	Type Pt100 Dimensions: d = 6 mm, l = 300 mm [d = 0.24 in, l = 11.81 in] Temperature range: -200 ... +450 °C [-328 ... +842 °F]	-45-
	Type K Dimensions: d = 3 mm, l = 300 mm [d = 0.12 in, l = 11.81 in] Temperature range: -100 ... +1,100 °C [-148 ... +2,012 °F]	-50-
	Type K Dimensions: d = 3 mm, l = 500 mm [d = 0.12 in, l = 19.69 in] Temperature range: -100 ... +1,100 °C [-148 ... +2,012 °F]	-60-
	Adapters for thermocouples DIN to TC miniature connector	-AD-
	Spare DIN connector for the probe	-CN-

Accessories for CTH6300		Order code
Description		CTX-A-H2
	Case set Consisting of: <ul style="list-style-type: none"> ■ Transport case, robust ■ 9 V battery ■ Interface cable ■ Software 	-CR-
	Case set Consisting of: <ul style="list-style-type: none"> ■ Transport case, robust ■ 9 V rechargeable battery and charger ■ Power supply unit ■ Interface cable ■ Software 	-CS-
	Case set Consisting of: <ul style="list-style-type: none"> ■ Transport case, robust ■ Power supply unit AC 100 ... 260 V ■ Interface cable ■ Software 	-CU-
	Service case with foam insert Material: Plastic	-SC-
	Protective bag against dirt and humidity Material: Plastic	-PS-
	9 V battery	-DB-
	9 V rechargeable battery	-RB-
	Battery charger for 9 V rechargeable batteries	-AC-
	AC adapter AC 100 ... 260 V, 50/60 Hz	-P1-
	AC adapter AC 230 V, 50/60 Hz	-P2-
	USB interface cable	-UB-

Accessories for CTH6300		Order code
Description		CTX-A-H2
	Calibration software DE-Graph software for Windows	-SG-
Ordering information for your enquiry:		
1. Order code: CPX-A-H2 2. Option:		↓ []

Accessories for CTH6310, explosion-protected version		Order code
Description		CTX-A-H3
	Immersion probe Type Pt100 Dimensions: d = 3 mm, l = 150 mm [d = 0.12 in, l = 5.91 in] Temperature range: -200 ... +450 °C [-328 ... +842 °F]	-10-
	Suitable for hazardous areas. Type Pt100 Dimensions: d = 3 mm, l = 300 mm [d = 0.12 in, l = 11.81 in] Temperature range: -200 ... +450 °C [-328 ... +842 °F]	-20-
	Suitable for hazardous areas. Type Pt100 Dimensions: d = 4 mm, l = 300 mm [d = 0.16 in, l = 11.81 in] Temperature range: -40 ... +500 °C [-40 ... +932 °F]	-40-
	Suitable for hazardous areas. Type Pt100 Dimensions: d = 6 mm, l = 300 mm [d = 0.24 in, l = 11.81 in] Temperature range: -200 ... +450 °C [-328 ... +842 °F]	-45-
	Spare DIN connector for the probe	-CN-
	Case set Consisting of: ■ Transport case, robust ■ 9 V battery ■ Interface cable ■ Software ⚠ May not be used in Ex areas!	-CR-
	Service case with foam insert Material: Plastic	-SC-
	Protective bag against dirt and humidity Material: Plastic	-PS-
	9 V battery	-DB-

Accessories for CTH6310, explosion-protected version		Order code
Description		CTX-A-H3
	USB interface cable ⚠ May not be used in Ex areas!	-UB-
	Calibration software DE-Graph software for Windows	-SG-
Ordering information for your enquiry:		
1. Order code: CPX-A-H3 2. Option:		↓ []

Other probes are available on request	
	Penetration probe
	Customer-specific probes

Scope of delivery

- Hand-held thermometer model CTH6300 or intrinsically safe hand-held thermometer model CTH6310
- 9 V battery
- 3.1 calibration certificate per DIN EN 10204
- Choice of temperature probes

Option

- DKD/DAkkS calibration certificate



Intrinsically safe hand-held thermometer, model CTH6510

Ordering information

Model / Version / Probe at input 1 / Probe at input 2 / Case set / Calibration / Test points for calibration certificate / Number of test points / Further approvals / Additional ordering information

© 04/2013 WIKA Alexander Wiegand SE & Co. KG, all rights reserved.
The specifications given in this document represent the state of engineering at the time of publishing.
We reserve the right to make modifications to the specifications and materials.

