

Float switch

For industrial applications, PNP or NPN switching outputs

Model GLS-1000

WIKA data sheet LM 50.10

Applications

- Level measurement of liquids in machine building
- Control and monitoring tasks for hydraulic power packs, compressors and cooling systems

Special features

- Replacement of traditional PNP/NPN limit level switches with float switches
- Several switch points and parallel temperature monitoring in a single instrument
- Distance of ≥ 2.5 mm between individual switch points enables the monitoring of very small level changes
- High accuracy of ≤ 1 mm allows reliable level monitoring



Fig. left: With cable outlet and float from Buna
Fig. right: With circular connector M12 x 1 and cylindrical float

Description

The innovative model GLS-1000 float switch has been developed for monitoring the levels of liquids. It combines the advantages of the proven and robust float-based measuring principle with modern digital switching technology with PNP and NPN output signals. The GLS-1000 is suitable for a multitude of media, such as, for example, oil, water, diesel and refrigerants.

Measuring principle

A permanent magnet built into the float, through its magnetic field, activates the semiconductor sensors built into the guide tube. The switching operation is contact-free and free from wear. Since no mechanical switching process is triggered, the sensor offers an unlimited number of switching cycles.

Depending on customer wishes, the switching functions of normally open and normally closed can be realised as PNP or NPN outputs for the defined switch position.

Specifications

Float switch, model GLS-1000	Level	Temperature
Measuring principle	The semiconductor level switch is triggered by a magnet within the float	Pt100/Pt1000 measuring resistor in pipe end
Measuring range	Guide tube length L: 60 ... 1,000 mm [2.4 ... 39.4 in]	Pt100/Pt1000 measuring resistor
Output signal	Up to 4 switch points, PNP or NPN	<ul style="list-style-type: none"> ■ Pt100, 2-wire, class B per DIN EN 60751 ■ Pt1000, 2-wire, class B per DIN EN 60751
Switching function	Alternatively normally open (NO) or normally closed (NC) - on rising level	
Switch position	Specified in mm, starting from the upper sealing face, selectable in 2.5 mm increments (0.1 inch increments) At the end of the guide tube ≈ 45 mm [≈ 1.8 in] cannot be used for switch positions.	
Switching current	Max. 200 mA	
Total current consumption	Per switching output: max. 10 mA + switching current	
Switch point accuracy	±1 mm	
Power supply	DC 5 ... 30 V	
Mounting position	±30°	
Process connection	<ul style="list-style-type: none"> ■ G 1, installation from outside ■ G 1 ½, installation from outside ■ G 2, installation from outside ■ G ¾, installation from inside ¹⁾ ■ G ½, installation from inside 	
Material	<ul style="list-style-type: none"> ■ Wetted Process connection, guide tube: Stainless steel 316Ti Float: See table on page 3 ■ Non-wetted Case: Stainless steel 316Ti Electrical connection: See table below 	
Permissible temperatures	<ul style="list-style-type: none"> ■ Medium -40 ... +80 °C [-40 ... +176 °F] -40 ... +110 °C [-40 ... +230 °F] ²⁾ ■ Ambient -40 ... +80 °C [-40 ... +176 °F] ■ Storage -30 ... +80 °C [-22 ... +176 °F] 	

Electrical connections	Ingress protection per IEC/EN 60529 ⁴⁾	Material	Cable length
Circular connector M12 x 1 (4-, 5- or 8-pin) ³⁾	IP65	TPU, brass	-
Cable outlet	IP67	PVC	<ul style="list-style-type: none"> ■ 2 m [6.5 ft] ■ 5 m [16.4 ft]
Cable outlet	IP67	PUR	other lengths on request
Cable outlet ⁵⁾	IP67	Silicone	

1) Only with cable outlets

2) Not with cable material: PVC, PUR

3) Not with process connection G ¾ female

4) The stated ingress protection (per IEC/EN 60529) only applies when plugged in using mating connectors that have the appropriate ingress protection.

5) With Pt100/Pt1000 - max. 2 switching outputs

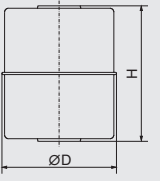
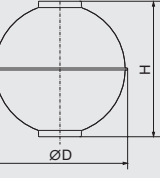
Float	Form	Outer diameter $\varnothing D$	Height H	Operating pressure	Medium temperature	Density	Material
	Cylinder ¹⁾	44 mm [1.7 in]	52 mm [2.0 in]	≤ 16 bar [≤ 232 psi]	≤ 110 °C [≤ 230 °F]	≥ 750 kg/m ³ [46.8 lbs/ft ³]	316 Ti
	Cylinder ²⁾	30 mm [1.2 in]	36 mm [1.4 in]	≤ 10 bar [≤ 145 psi]	≤ 110 °C [≤ 230 °F]	≥ 850 kg/m ³ [53.1 lbs/ft ³]	316 Ti
	Cylinder	25 mm [1.0 in]	20 mm [0.8 in]	≤ 16 bar [≤ 232 psi]	≤ 80 °C [≤ 176 °F]	≥ 750 kg/m ³ [46.8 lbs/ft ³]	Buna / NBR
	Ball ³⁾	52 mm [2.0 in]	52 mm [2.0 in]	≤ 40 bar [≤ 580 psi]	≤ 110 °C [≤ 230 °F]	≥ 750 kg/m ³ [46.8 lbs/ft ³]	316 Ti

1) Not with process connection G 1

2) Max. 2 switching outputs or 1 switching output + Pt100/Pt1000, not with process connection G 1 ½, G 2, max. 300 mm [11.8 inch]

3) Not with process connection G 1, G 1 ½

Connection diagram

Circular connector M12 x 1 (4-pin)		
	1 switch point U+ = 1 U- = 3 SP1 = 4	2 switch points U+ = 1 SP2 = 2 U- = 3 SP1 = 4

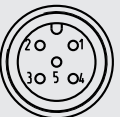
Circular connector M12 x 1 (5-pin)		
	1 switch point + temperature output U+ = 1 U- = 3 SP1 = 4 Pt100, Pt1000 = 2/5	3 switch points U+ = 1 SP2 = 2 U- = 3 SP1 = 4 SP3 = 5

Circular connector M12 x 1 (8-pin)		
	U+ = 1 U- = 3 Pt100, Pt1000 = 7/8 SP1 = 4 SP2 = 2 SP3 = 5 SP4 = 6	Pin assignment depends upon the output signal combination (2, 3 or 4 switch points, with option of Pt100 or Pt1000); otherwise, pins are not assigned

Cable outlet

	1 - 4 switch points U+ = WH U- = BN SP1 = GN (SP2 = YE) (SP3 = GY) (SP4 = PK)	1 switch point + temperature output U+ = WH U- = BN SP1 = GN Pt100/Pt1000 = YE/GY	2 switch points + temperature output U+ = WH U- = BN SP1 = GN SP2 = YE Pt100/Pt1000 = GY/PK
	3 switch points + temperature output U+ = WH U- = BN SP1 = GN SP2 = YE SP3 = GY Pt100/Pt1000 = PK/BU	4 switch points + temperature output U+ = WH U- = BN SP1 = GN SP2 = YE SP3 = GY SP4 = PK Pt100/Pt1000 = BU/RD	

Legend

SP1 - SP4	Switch points
U+	Positive power supply terminal
U-	Negative power supply terminal
WH	White
BN	Brown
GN	Green
YE	Yellow
GY	Grey
PK	Pink
BU	Blue
RD	Red

Electrical safety

Short-circuit resistance	SP1 / SP2 / SP3 / SP4 vs. U-
Reverse polarity protection	U+ vs. U-
Insulation voltage	DC 500 V
Overvoltage protection	DC 40 V

Dimensions in mm [in]

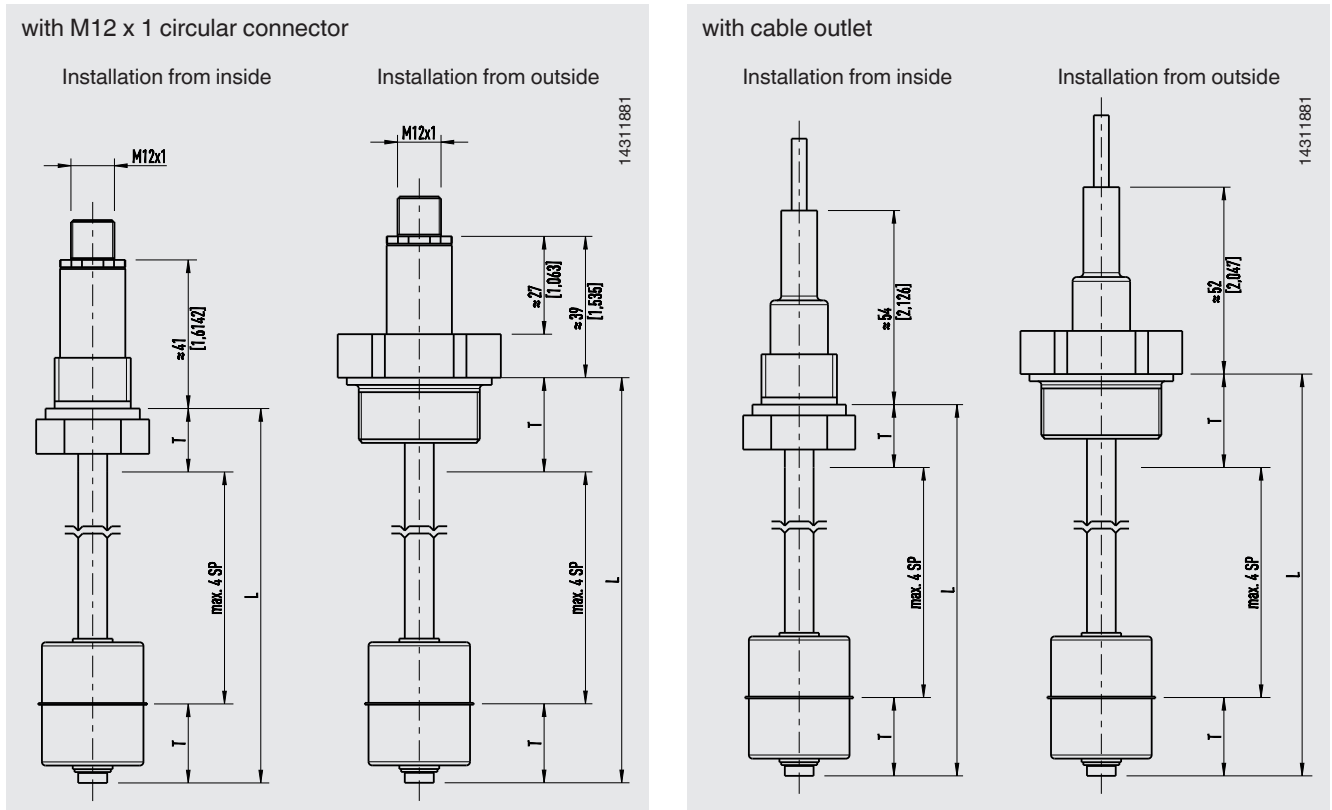

Legend

- L Guide tube length
- T Non-usable range for switch positions

Dead band T float switch in mm [in] (from sealing edge)

Process connection	Outer diameter float Ø D			
	Ø 30 mm [1.2 in]	Ø 44 mm [1.7 in]	Ø 52 mm [2.0 in]	Ø 25 mm [1.0 in]
G 1	30 mm [1.2 in]	-	-	25 mm [1.0 in]
G 1 ½	30 mm [1.2 in]	40 mm [1.6 in]	-	25 mm [1.0 in]
G 2	30 mm [1.2 in]	40 mm [1.6 in]	40 mm [1.6 in]	25 mm [1.0 in]
G ¾ B	25 mm [1.0 in]	30 mm [1.2 in]	30 mm [1.2 in]	20 mm [0.8 in]
G ½ B	25 mm [1.0 in]	30 mm [1.2 in]	30 mm [1.2 in]	20 mm [0.8 in]

Dead band T in mm [in] (pipe end)

Dead band	Outer diameter float Ø D			
	Ø 30 mm [1.2 in]	Ø 44 mm [1.7 in]	Ø 52 mm [2.0 in]	Ø 25 mm [1.0 in]
T	30 mm [1.2 in]	45 mm [1.8 in]	45 mm [1.8 in]	25 mm [1.0 in]

Process connection

Installation from outside

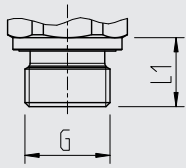

Installation from inside

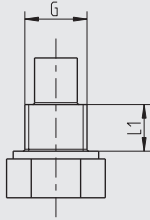

G	L ₁
G 1	16 mm [0.63 in]
G 1 ½	18 mm [0.71 in]
G 2	20 mm [0.79 in]

G	L ₁
G ⅝ B	12 mm [0.47 in]
G ½ B	14 mm [0.55 in]

Accessories

Circular connector M12 x 1 with moulded cable

	Description	Temperature range	Cable diameter	Cable length	Order no.
	Straight version, cut to length, 4-pin, PUR cable, UL listed, IP67	-20 ... +80 °C [-4 ... +176 °F]	4.5 mm [0.18 in]	2 m [6.6 ft]	14086880
	Straight version, cut to length, 4-pin, PUR cable, UL listed, IP67	-20 ... +80 °C [-4 ... +176 °F]	4.5 mm [0.18 in]	5 m [16.4 ft]	14086883
	Straight version, cut to length, 4-pin, PUR cable, UL listed, IP67	-20 ... +80 °C [-4 ... +176 °F]	4.5 mm [0.18 in]	10 m [32.8 ft]	14086884
	Straight version, cut to length, 5-pin, PUR cable, UL listed, IP67	-20 ... +80 °C [-4 ... +176 °F]	5.5 mm [0.22 in]	2 m [6.6 ft]	14086886
	Straight version, cut to length, 5-pin, PUR cable, UL listed, IP67	-20 ... +80 °C [-4 ... +176 °F]	5.5 mm [0.22 in]	5 m [16.4 ft]	14086887
	Straight version, cut to length, 5-pin, PUR cable, UL listed, IP67	-20 ... +80 °C [-4 ... +176 °F]	5.5 mm [0.22 in]	10 m [32.8 ft]	14086888
	Straight version, cut to length, 8-pin, PUR cable, UL listed, IP67	-20 ... +80 °C [-4 ... +176 °F]	5.5 mm [0.22 in]	5 m [16.4 ft]	14133913
	Angled version, cut to length, 4-pin, PUR cable, UL listed, IP67	-20 ... +80 °C [-4 ... +176 °F]	4.5 mm [0.18 in]	2 m [6.6 ft]	14086889
	Angled version, cut to length, 4-pin, PUR cable, UL listed, IP67	-20 ... +80 °C [-4 ... +176 °F]	4.5 mm [0.18 in]	5 m [16.4 ft]	14086891
	Angled version, cut to length, 4-pin, PUR cable, UL listed, IP67	-20 ... +80 °C [-4 ... +176 °F]	4.5 mm [0.18 in]	10 m [32.8 ft]	14086892
	Angled version, cut to length, 5-pin, PUR cable, UL listed, IP67	-20 ... +80 °C [-4 ... +176 °F]	5.5 mm [0.22 in]	2 m [6.6 ft]	14086893
	Angled version, cut to length, 5-pin, PUR cable, UL listed, IP67	-20 ... +80 °C [-4 ... +176 °F]	5.5 mm [0.22 in]	5 m [16.4 ft]	14086894
	Angled version, cut to length, 5-pin, PUR cable, UL listed, IP67	-20 ... +80 °C [-4 ... +176 °F]	5.5 mm [0.22 in]	10 m [32.8 ft]	14086896

Connection cable M12 x 1 with integrated LED indicator

	Description	Temperature range	Cable length	Order no.
	Connection cable, 4-pin, PUR cable, UL listed, IP67 1x LED green, 2x LED yellow	-20 ... +80 °C [-4 ... +176 °F]	2 m [6.6 ft]	14252834
	Connection cable, 4-pin, PUR cable, UL listed, IP67 1x LED green, 2x LED yellow	-20 ... +80 °C [-4 ... +176 °F]	5 m [16.4 ft]	14252835

Approvals

Logo	Description	Country
	EU declaration of conformity <ul style="list-style-type: none">■ EMC directive■ RoHS directive	European Union

Manufacturer's information and certificates

Logo	Description
-	China RoHS directive

Approvals and certificates, see website

Ordering information

Model / Level and temperature output signals / Switching function / Switch point position / Electrical connection / Process connection / Guide tube length L / Medium temperature / Float

© 11/2018 WIKA Alexander Wiegand SE & Co. KG, all rights reserved.
The specifications given in this document represent the state of engineering at the time of publishing.
We reserve the right to make modifications to the specifications and materials.

